



Free Combination

200 W Output Capacity. 3 New Models!



New

Compact Multi-Output DC Power Supply PMX-Multi Series

- Three models with 2, 3 and 4 outputs
- Each output is isolated
- High setting resolution (Voltage: 1 mV, Current: 0.1 mA)
- Tracking control in all channels
- Simultaneous display of all channel statuses
- ON/OFF delay of each output
- Simple series/parallel connection between channels (CH1 & CH2)
- LAN (LXI Compliant)/USB/RS232C standard interface
- Turning output on and off using an external contact
- Remote sensing function
- Key lock, Preset memory function (3 slots)
- High quality LCD panel for improved visibility

Free Combination

Compact Multi-Output DC Power Supply PMX-Multi Series

NEW

Each output is isolated.

Simple series/parallel connection between channels.

200 W Output Capacity.

Three models with 2, 3 and 4 outputs.

The PMX-Multi series is a multi-channel DC power supply with isolated outputs on each channel. The PMX32-3DU (2ch), PMX32-3TR (3ch), and PMX32-2QU (4ch) are all capable of simultaneous output in all channels and come with an output tracking feature.

Also, channels 1 & 2 of each model can be easily connected in either series or parallel to increase the output voltage/current at the press of a button. LAN (LXI Compliant), USB, and RS232C are included as standard digital interfaces for easy system integration.

The PMX-Multi benefits from a low noise, series regulator design that makes this series the perfect choice for experiments involving transistors, IC circuits, and op amp circuits as well as R&D and production line applications.

- Three models with 2, 3 and 4 outputs.
- Each output is isolated.
- High setting resolution. (Voltage: 1 mV, Current: 0.1 mA)
- Tracking control in all channels.
- Simultaneous display of all channel statuses.
- ON/OFF delay of each output.
- Simple series/parallel connection between channels. (CH1 & CH2)
- LAN (LXI Compliant)/USB/RS232C standard interface.
- Turning output on and off using an external contact.
- Remote sensing function.
- Key lock, Preset memory function. (3 slots)
- High quality LCD panel for improved visibility.

Application

- Power supply for tests involving transistors, IC circuits and operational amplifiers
- Integration into semiconductor evaluation test systems
- Power supply for research and development and manufacturing line integration



Actual
Size

Sensing terminal



PMX-MULTI SERIES

TRACK key P4 for further details

DELAY key P5 for further details

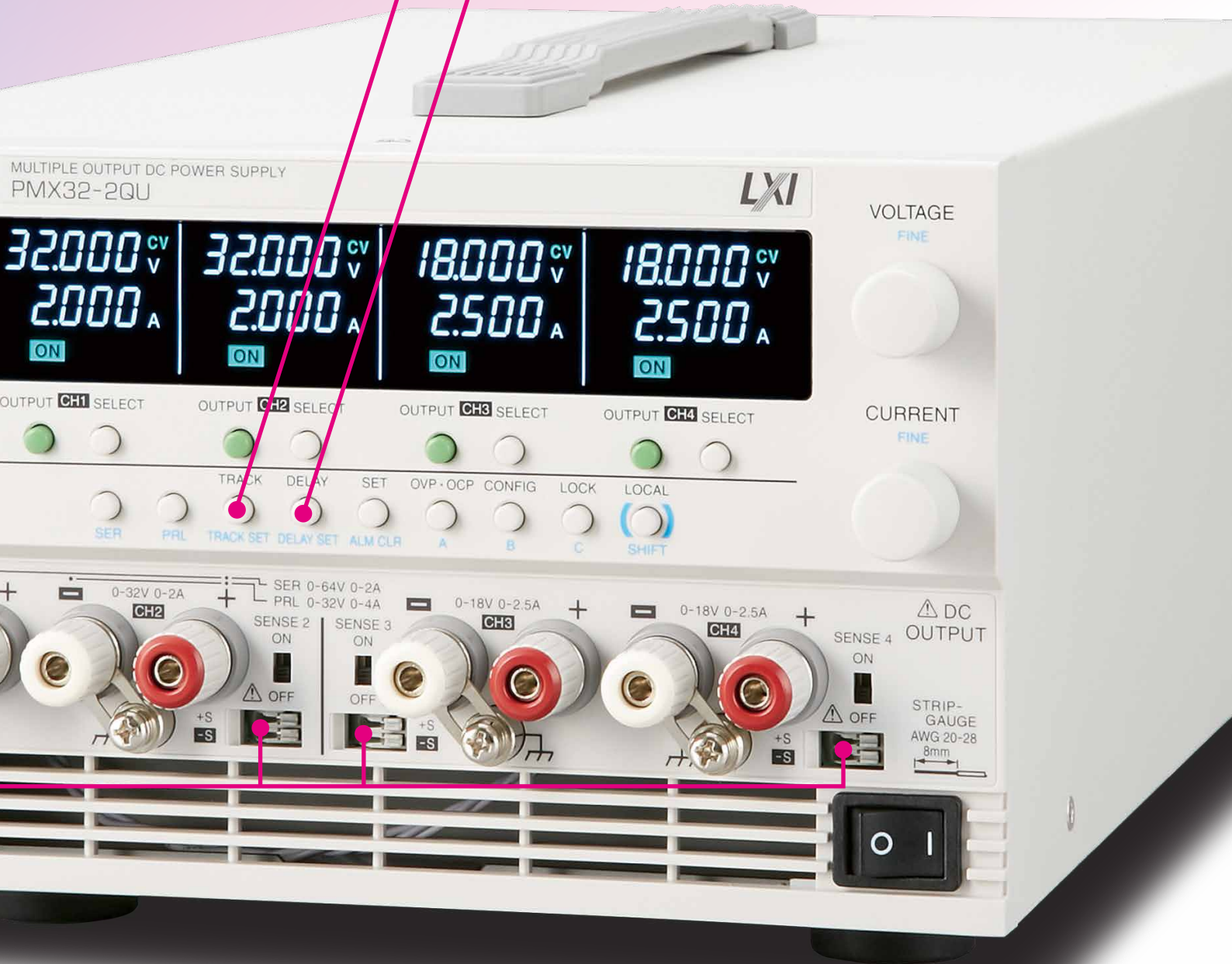

PMX32-2QU (four-output)

Lineup/Main Specification

Specifications	Output			Ripple		Line Regulation		Load Regulation		Input	Power	Weight
	CH	CV	CC	CV	CC	CV	CC	CV	CC	AC	Approx.	Approx.
PMX32-3DU	1	32.000 V	3.000 A	500 μ V	1 mA	3 mV	0.01% +0.25 mA	4 mV	5 mA	217 Vac* \pm 10%	700 VA	13 kg (28.66 lb)
	2	32.000 V	3.000 A		1 mA	3 mV		4 mV				
PMX32-3TR	1	32.000 V	3.000 A		1 mA	3 mV		4 mV				
	2	32.000 V	3.000 A		1 mA	3 mV		4 mV				
PMX32-2QU	3	6.000 V	5.000 A		2 mA	1 mV		5 mV			2 mV	
	1	32.000 V	2.000 A		1 mA	3 mV		2 mV			800 VA	
	2	32.000 V	2.000 A		1 mA	3 mV		2 mV				
	3	18.000 V	2.500 A		1 mA	1 mV		3 mV				
4	18.000 V	2.500 A	1 mA	1 mV	3 mV							

* 100 Vac, 117 Vac, 200 Vac and 234 Vac are factory options.

Simple Series/Parallel Connection Between Channels

Series Operation

CH1 and CH2 can be connected in series to increase the overall voltage output range. CH2 operates as master and CH1 as slave. The total output voltage will be the sum of CH1 and CH2.

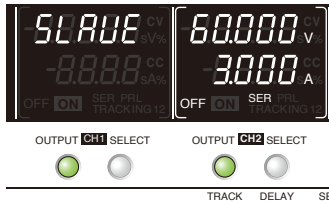

Panel display during series operation

- Output voltage: 60 V
CH1: 30 V+CH2: 30 V
- Output current: 3 A

Parallel Operation

CH1 and CH2 can be connected in parallel to increase the overall current range. CH2 operates as master and CH1 as slave. The total output current will be the sum of CH1 and CH2.

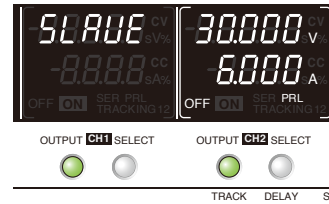

Panel display during parallel operation

- Output voltage: 30 V
- Output current: 6 A
CH1: 3 A+CH2: 3 A

Series operation (CH1 and CH2) load connection
If CH1 negative terminal is connected to the chassis terminal

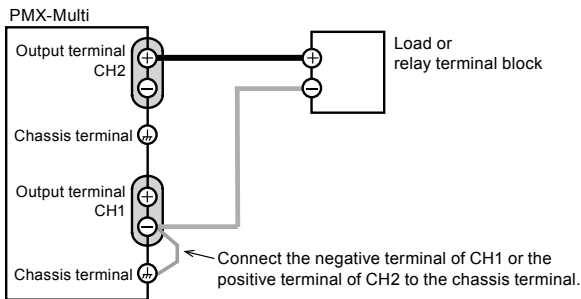

Parallel operation (CH1 and CH2) load connection

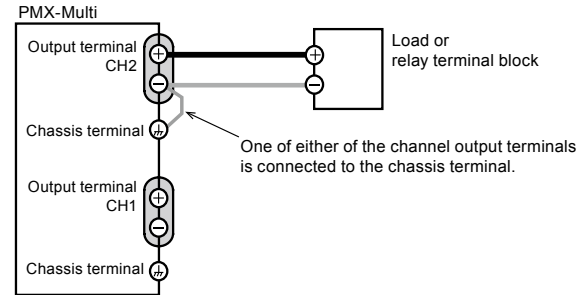

Note: Connect load wiring to the CH2 output terminal. Connection to CH1 can cause damage.

Tracking Feature

The tracking feature allows the operator to control the ratio for increase/decrease of output among multiple channels within the power rating. This feature can be used freely among all channels with two ratio options: absolute value variation and variation ratio.

Absolute Value Variation

This mode allows for voltage/current settings in all specified channels to change at the same rate as a selected channel.

Variation Ratio

This mode allows for voltage/current settings in all specified channels to change in equal proportion to a selected voltage or current rating.

*The variable range is from 0.0% to 200.0%

Example of operation of tracking feature: PMX32-2QU

When you turn the rotary knob during tracking operation, the outputs change at the same percentage as the preset output percentage (b/a).

$$b/a = d/c$$

This proportional expression is satisfied.

Example when the voltage is changed within the rated output

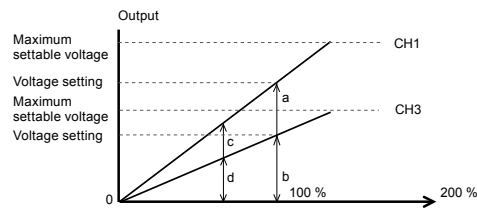

Example when the voltage is changed above the maximum settable output

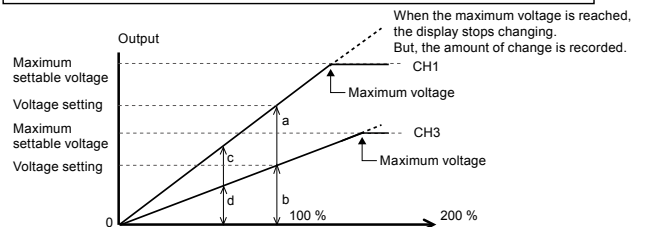

Delay Function

The optional setting creates a programmable delay between the OUTPUT switch being activated and the actual output being released. The setting range for DELAY TIME is from 0.1 - 99.9 seconds.

When power supplies are not activated properly, there is the slight risk of damage being caused to the overall system. For this reason ON delay control is a very important feature that is required for power source output. This feature is also necessary when turning output OFF, and is highly convenient for operating circuits.

[Timing chart of delay function]

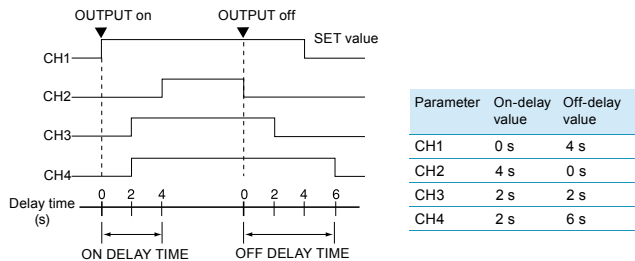

Note: The actual rise/fall time with output off will vary depending on the output and load conditions. Note that the timing chart above ignores rise and fall time. There are cases where the actual delay time varies by a few tens of milliseconds even when the delay time is set to 0 seconds.

Easy Access with the Built-in Web Server

Use a browser from a PC, smartphone, or tablet to access the web server built into the PMX-Multi series for convenient control and monitoring.

[Recommended browser]

- Requires for the Internet Explorer version 9.0 or later
- Requires for the firefox 8.0 or later
- Requires for the safari / mobile Safari 5.1 or later
- Requires for the Chrome 15.0 or later
- Requires for the Opera 11.0 or later

*Connecting with a smartphone, tablet, etc. requires a Wi-Fi environment (wireless LAN router etc.).



Rear Panel

LAN (LXI Compliant)/USB/RS232C standard interface

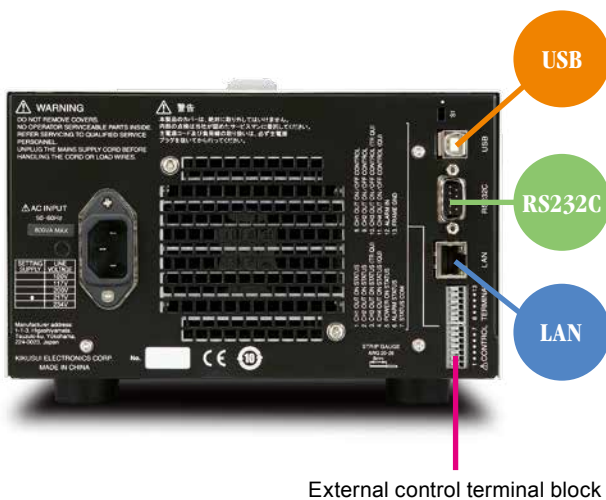

External control terminal block

Pin arrangement of the CONTROL TERMINAL

The CONTROL TERMINAL on the rear panel can be turning output on and off using an external contact.

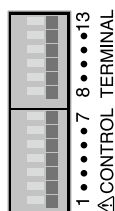

Turning output on and off using an external contact

Connection when 2 outputs are turned ON/OFF

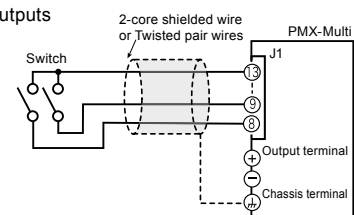

Pin no.	Signal name	Description
1	OUTPUT ON STATUS(CH1)	On when output is on (output through an open-collector photocoupler). *1
2	OUTPUT ON STATUS(CH2)	
3	OUTPUT ON STATUS(CH3)	
4	OUTPUT ON STATUS(CH4)	
5	POWER ON STATUS	On when the power is on (output through an open-collector photocoupler). *1
6	ALARM STATUS	On when a protection function (OVP, OCP, OHP) is activated or when an alarm signal (ALARM IN) is received.
7	STATUS COM	Status signal common for pins 1 to 6.
8	OUTPUT ON/ OFF CONTROL(CH1)	Output on/off control using external contact input.
9	OUTPUT ON/ OFF CONTROL(CH2)	
10	OUTPUT ON/ OFF CONTROL(CH3)	
11	OUTPUT ON/ OFF CONTROL(CH4)	
12	ALARM IN	All channel outputs are turned off when an alarm signal is received.
13	FRAME GND	External signal common for pins 8 to 12. *2

*1 Open collector output: Maximum voltage of 30 V and maximum current of 8 mA.

*2 The status common is floating (isolation voltage or less). It is isolated from the control circuit.
*2 FRAME GND is connected to the chassis.

Specifications

Unless specified otherwise, the specifications are for the following settings and conditions.

- Loads are purely resistive loads.
- The product is warmed up for at least 30 minutes.
- The negative output is connected to the chassis terminal with a short bar.
- Values indicated by "TYP" are typical values. These values do not guarantee the performance of the PMX series (multiple-output).
- rating: Indicates the rated. • set: Indicates a setting. • reading: Indicates the readout value.
- Rated load and no load are defined as follows:

In constant-voltage mode (when the output current is set to a value greater than or equal to the maximum output current with rated output voltage)
 Rated load: Refers to a resistive load that, when the rated output voltage is applied, makes the flowing current 95 % to 100 % of the maximum output current with rated output voltage.

No load: Refers to a load through which no output current flows. In other words, refers to an open load (no load being connected).

In constant-current mode (when the output voltage is set to a value greater than or equal to the maximum output voltage with rated output current)

Rated load: Refers to a resistive load that, when the rated output current flows, makes the voltage drop to 95 % to 100 % of the maximum output voltage with rated output current. Including the voltage drop in the load cables, the product's output voltage must not exceed the maximum output voltage with rated output current.

No load: Refers to a resistive load that, when the rated output current flows, makes the voltage drop to 10 % of the maximum output voltage with rated output current or 1 V whichever is higher.

■AC Input

Item	PMX32-3DU	PMX32-3TR	PMX32-2QU
Nominal input rating	217 Vac *1, 50 Hz/ 60 Hz, single phase		
Input voltage range	± 10%		
Input frequency range	47 Hz to 63 Hz		
Inrush current (MAX) *2	150 Amax	150 Amax	150 Amax
Power (MAX)	700 VA	900 VA	800 VA

*1. 100 Vac, 117 Vac, 200 Vac, and 234 Vac are factory options.

*2. Excludes the charge current component that flows through the capacitor of the internal EMI filter circuit immediately after the POWER switch is turned on (for approximately 1 ms).

■Output

Item		PMX32-3DU	PMX32-3TR	PMX32-2QU	
Rating	Output voltage	CH1	32.000 V	32.000 V	32.000 V
		CH2	32.000 V	32.000 V	32.000 V
		CH3	—	6.000 V	18.000 V
		CH4	—	—	18.000 V
	Output current	CH1	3.000 A	3.000 A	2.000 A
		CH2	3.000 A	3.000 A	2.000 A
		CH3	—	5.000 A	2.500 A
		CH4	—	—	2.500 A
Maximum voltage setting	CH1	33.600 V	33.600 V	33.600 V	
	CH2	33.600 V	33.600 V	33.600 V	
	CH3	—	6.300 V	18.900 V	
	CH4	—	—	18.900 V	
Resolution		1 mV			
Voltage setting accuracy *1		±(0.03% set +5 mV)			
Input line regulation *2	CH1	3 mV	3 mV	3 mV	
	CH2	3 mV	3 mV	3 mV	
	CH3	—	1 mV	1 mV	
	CH4	—	—	1 mV	
Load regulation *3	CH1	4 mV	4 mV	2 mV	
	CH2	4 mV	4 mV	2 mV	
	CH3	—	5 mV	3 mV	
	CH4	—	—	3 mV	
Transient response *4		50 μs			
Ripple noise (rms) *5		500 μV			
Command delay		80 ms			
Rise time (at rated load) *6		10 ms ±30%			
Fall time (at no load) *7	CH1	350 ms ±30%	350 ms ±30%	350 ms ±30%	
	CH2	350 ms ±30%	350 ms ±30%	350 ms ±30%	
	CH3	—	220 ms ±30%	240 ms ±30%	
	CH4	—	—	240 ms ±30%	
Temperature coefficient (TYP)		100 ppm/°C			
Maximum current setting	CH1	3.150 A	3.150 A	2.100 A	
	CH2	3.150 A	3.150 A	2.100 A	
	CH3	—	5.250 A	2.625 A	
	CH4	—	—	2.625 A	
Resolution		0.1 mA			
Current setting accuracy *1		±(0.3% set +0.1% rating)			
Input line regulation *2		0.01% + 0.25 mA			
Load regulation *8		5 mA			
Ripple noise (rms) *5	CH1	1 mA	1 mA	1 mA	
	CH2	1 mA	1 mA	1 mA	
	CH3	—	2 mA	1 mA	
	CH4	—	—	1 mA	
Temperature coefficient (TYP)		200 ppm/°C			

*1. At an ambient temperature of 23 °C ±5 °C.

*2. 90% to 100% or 100% to 110% of the nominal input voltage rating, rated load.

*3. The amount of change that occurs when the load is changed from no load to rated load at the rated output voltage. The value is measured at the sensing point.

*4. The amount of time required for the output voltage to return to a value within "rated output voltage ± (0.05% + 10 mV)." When the load current is changed from 10% to 100% of the rated output current. The value is measured at the sensing point.

*5. When the measurement frequency bandwidth is 5 Hz to 1 MHz.

*6. The time for the output voltage to rise from 10% to 90% of the rating when the output is turned on.

*7. The time for the output voltage to fall from 90% to 10% of the rating when the output is turned off.

*8. The amount of current change when the load is changed from 10% of the rated voltage or 1 V, whichever is higher, to the rated voltage at rated output current.

■Display Function

Item		PMX32-3DU	PMX32-3TR	PMX32-2QU	
Volt-meter	Maximum display	99.999 (fixed decimal point)			
	Display accuracy *1	±(0.1% of reading +10 mV)			
Am-meter	Maximum display	9.999 (fixed decimal point)			
	Display accuracy *1	±(0.2% of reading +5 mA)			
Operation display	OUTPUT ON/OFF	Output on: "ON" display (green) Output off: "OFF" display			
	Output-on delay/off delay	Displays "DELAY SET" when set. "DELAY" blinks during output-on delay/off delay. "DELAY" is displayed after the output-on delay/off delay has passed.			
	CV operation	"CV" display (green)			
	CC operation	"CC" display (red)			
	Alarm operation	Displays "ALARM" (red) when a protection function is activated.			
	Memory	Displays "PRESET A," "PRESET B," or "PRESET C" when a memory area is in use.			
	key lock	Displays "LOCK" when the keys are locked.			
	Tracking	Displays "TRACKING 1" or "TRACKING 2" when tracking is in operation.			
	Remote operation		Displays "REMOTE" during remote control.		
		LAN operation	Displays or blinks "LAN" (depending on the status). • No fault status: Lights green. • Fault status: red. • Standby status: Blinks red. • WEB identify status: Blinks green.		

*1. At an ambient temperature of 23 °C±5 °C.

■Protection Function

Item		PMX32-3DU	PMX32-3TR	PMX32-2QU
Overvoltage protection (OVP)	Action	Turns the output off, displays "OVP," and displays "ALARM" (red).		
	Setting range	10% to 110% of the rated output voltage		
	Setting accuracy	±(1% of rating)		
	Resolution	1 mV		
Overcurrent protection (OCP)	Action *1	Turns the output off, displays "OCP," and displays "ALARM" (red).		
	Setting range	10% to 110% of the rated output current		
	Setting accuracy	±(1% of rating)		
Overheat protection (OHP)	Resolution	0.1 mA		
	Action	Turns the output off, displays "OHP," and displays "ALARM" (red).		

*1. This does not protect against the discharge current peak that is generated from the capacitors inside the product's output section when the load is changed suddenly.

■Signal Output

Item		PMX32-3DU	PMX32-3TR	PMX32-2QU
Status Signal output *1	OUTPUT ON STATUS	On when output is on.		
	ALARM STATUS	On when an alarm is activated (OVP, OCP, OHP).		
	POWER ON STATUS	Turns on when the power is turned on		

*1. Photocoupler open collector output; Maximum voltage 30 V, maximum current (sink) 8 mA. Isolated from the output and control circuits. The status common is floating (within the isolation voltage).

■Control Functions

Item		PMX32-3DU	PMX32-3TR	PMX32-2QU
External control	Output on/off control (OUTPUT ON/OFF CONT)	Logic selectable: • Negative logic Output on when set to LOW (0 V to 0.5 V) or shorted; output off when set to HIGH (4.5 V or 5 V) or open • Positive logic Output on when set to HIGH (4.5 V to 5 V) or open; output off when set to LOW (0 V or 0.5 V) or shorted		

■Sensing

Item		PMX32-3DU	PMX32-3TR	PMX32-2QU
Sensing		0.6 V for a single line (but the output terminals are controlled at the rated voltage)		

Parallel Operation and Series Operation

Item	PMX32-3DU	PMX32-3TR	PMX32-2QU	
Parallel operation				
Applicable channels		Master: CH2, slave: CH1		
Constant voltage	Operating range	0 V to 32 V		
	Setting range	0 V to 33.6 V		
	Setting accuracy	0.3% set + 0.1% rating		
	Resolution	1 mV		
Constant current	Operating range	0 A to 6 A	0 A to 6 A	0 A to 4 A
	Setting range	0 A to 6.3 A	0 A to 6.3 A	0 A to 4.2 A
	Setting accuracy	0.4% set + 0.1% rating		
	Resolution	0.2 mA		
Volt-meter	Maximum display	99.999 (fixed decimal point)		
	Display accuracy *1	±(0.5% of reading + 10 digit)		
Am-meter	Maximum display	9.999 (fixed decimal point)		
	Display accuracy *1	±(1% of reading + 10 digit)		
Series operation				
Applicable channels		Master: CH2, slave: CH1		
Constant voltage	Operating range	0 V to 64 V		
	Setting range	0 V to 67.2 V		
	Setting accuracy *1 *2	0.3% set + 0.1% rating		
	Resolution	2 mV		
Constant current	Operating range	0 A to 3 A	0 A to 3 A	0 A to 2 A
	Setting range	0 A to 3.15 A	0 A to 3.15 A	0 A to 2.1 A
	Setting accuracy *1	0.4% set + 0.1% rating		
	Resolution	0.1 mA		
Volt-meter	Maximum display	99.999 (fixed decimal point)		
	Display accuracy *1	±(0.5% of reading + 20 digit)		
Am-meter	Maximum display	9.999 (fixed decimal point)		
	Display accuracy *1	±(1% of reading + 5 digit)		

*1 At an ambient temperature of 23 °C ±5 °C.

*2 The value is measured at the sensing point.

Other Functions

Item	PMX32-3DU	PMX32-3TR	PMX32-2QU	
Output-on delay/ off delay				
	Applicable channels	All channels		
	Setup	Set the output on/off delay time.		
	Setting range	0.1s to 99.9s		
	Resolution	0.1s		
	Setting accuracy *1	±50ms		
Memory	Saves three combinations of voltage, current, OVP, OCP, and output-on delay/ off delay settings.			
Key lock	Selectable from the following three modes. <ul style="list-style-type: none"> • Loc1: Lock all keys except the OUTPUT and memory A, B, and C keys. • Loc2: Lock all keys except the OUTPUT key. • Loc3: Lock all keys and the rotary knob. 			
Tracking				
Applicable channels		All channels		
Operation mode	Tracking function 1 *2	Absolute value change		
	Tracking function 2 *3	Percentage change		
Setting accuracy	CV setting accuracy	0.4% of rating + 40 mV		
	CC setting accuracy	0.7% of rating + 10 mA		

*1 The difference between the time from when the reference output reaches 5% of the setting to when the target output reaches 5% of the setting and the delay time setting.

*2 In tracking function 1, the output can be varied within the output range of the reference channel voltage or current.

*3 In tracking function 2, the output can be varied at the same percentage as the reference output in reference to the output at the start of the tracking function.

Interface

Item	PMX32-3DU	PMX32-3TR	PMX32-2QU
Common specifications	Software protocol	IEEE Std 488.2-1992	
	Command language	Complies with SCPI Specification 1990.0	
RS232C	Hardware	Complies with the EIA232D specifications (excluding the terminal block) D-sub 9-pin terminal block (male) Baudrate: 1200, 2400, 4800, 9600, 19200, 38400, 57600, 115200 bps Data length: 8 bits, Stop bits: 1 bit, Parity bit: None Flow control: No	
	Program message terminator	LF during reception, LF during transmission.	
USB	Hardware	Standard type B socket. Complies with the USB 2.0 specifications; data rate: 12 Mbps (full speed)	
	Program message terminator	LF or EOM during reception, LF + EOM during transmission.	
	Device class	Complies with the USBTMC-USB488 device class specifications.	
LAN	Hardware	IEEE 802.3 100Base-TX/10Base-T Ethernet IPv4, RJ-45 terminal block	
	Compliant standards	LXI Device Specification 2016 LXI HiSLIP Extended Function Rev. 1.0 LXI VXI-11 Extended Function Rev. 1.0	
	Communication protocol	VXI-11, HiSLIP, SCPI-RAW, SCPI-Telnet	
	Message terminator	VXI-11, HiSLIP: LF or END during reception, LF + END during transmission. SCPI-RAW: LF during reception, LF during transmission.	

General Specifications

Item	PMX32-3DU	PMX32-3TR	PMX32-2QU
Weight (main unit only)	Approx. 13 kg (28.66 lb)		
Dimensions (mm(inches))	214(8.46)W×124(4.88)(MAX155(6.10))H×400(15.75)(MAX435(17.13))D		
Environmental conditions	Operating temperature range	0 °C to 40 °C (32 °F to 104 °F)	
	Operating humidity range	20%rh to 85%rh (no condensation)	
	Storage temperature range	-25°C to 70°C (-13°F to 158°F)	
	Storage humidity range	90%rh or less (no condensation)	
Isolation voltage	Installation location	Indoor use, altitude of up to 2000 m, overvoltage category II	
	Between channels	±70 Vdc	
Withstanding voltage	Between the output and chassis	±70 Vdc	
	Between the primary circuit and chassis	No abnormalities at 1500 Vac for 1 minute.	
Insulation resistance	Between the primary and secondary circuits	No abnormalities at 2600 Vac for 1 minute.	
	Between the secondary circuit and chassis	No abnormalities at 1500 Vdc for 1 minute.	
Cooling method	Between the primary circuit and chassis	500 Vdc, 30 MΩ or greater	
	Between the primary and secondary circuits	500 Vdc, 30 MΩ or greater	
	Between the secondary circuit and chassis	500 Vdc, 30 MΩ or greater	
Common	Forced air cooling using a fan motor		
Grounding polarity	All channels are independent.		
Accessories	Negative grounding or positive grounding possible		
	Power cord: 1 pc. (The attached power cord varies depending on the shipment destination.) Output terminal cover set: 1 set, CD-ROM: 1 disc, Packing list: 1 copy, Safety Information: 1 copy		
Electromagnetic compatibility (EMC) *1 *2	Complies with the requirements of the following directive and standards. EMC Directive 2014/30/EU EN 61326-1(Class A *3) EN 55011(Class A *3, Group 1 *4) EN 61000-3-2, EN 61000-3-3 Applicable under the following conditions. The maximum length of all cabling and wiring connected to the product must be less than 3 m.		
Safety *1	Complies with the requirements of the following directive and standards. Low Voltage Directive 2014/35/EU *2 EN 61010-1 (Class I *5, Pollution Degree 2 *6)		

*1 Does not apply to specially ordered or modified products.

*2 Only on models that have the CE marking on the panel.

*3 This product conforms to Class A. This product is intended for use in an industrial environment. This product may cause interference if used in residential areas. Such use must be avoided unless the user takes special measures to reduce electromagnetic emissions to prevent interference to the reception of radio and television broadcasts.

*4 This is a Group 1 instrument. This product does not generate and/or use intentionally radio-frequency energy, in the form of electromagnetic radiation, inductive and/or capacitive coupling, for the treatment of material or inspection/analysis purpose.

*5 This product conforms to Class I. Be sure to ground the protective conductor terminal of this product. If not grounded properly, safety is not guaranteed.

*6 Pollution is addition of foreign matter (solid, liquid or gaseous) that may produce a reduction of dielectric strength or surface resistivity. Pollution Degree 2 assumes that only non-conductive pollution will occur except for an occasional temporary conductivity caused by condensation.

External Dimensions

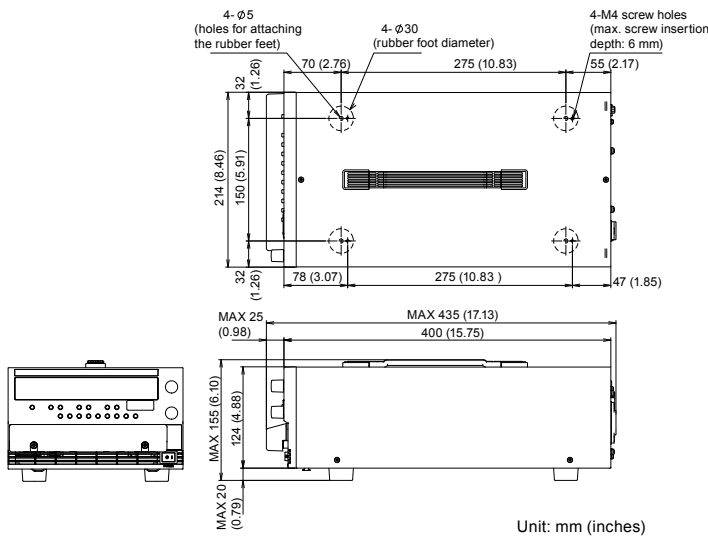

Options

Rack Mounting Options

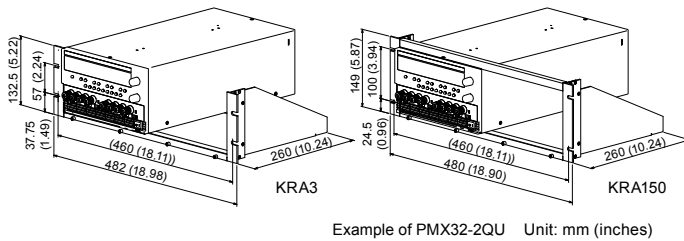

Name	Rack mount adapter	
Model	KRA3	KRA150
Note	For EIA inch racks	For JIS millimeter racks



KIKUSUI ELECTRONICS CORPORATION

Southwood 4F,6-1 Chigasaki-chuo,Tsuzuki-ku,Yokohama,224-0032,Japan
Phone: (+81)45-482-6353,Facsimile: (+81)45-482-6261,www.kikusui.co.jp

KIKUSUI AMERICA, INC. 1-310-214-0000 www.kikusuiamerica.com



3625 Del Amo Blvd, Suite 160, Torrance, CA 90503
Phone: 310-214-0000 Facsimile: 310-214-0014

KIKUSUI TRADING (SHANGHAI) Co., Ltd. www.kikusui.cn



Room 305,Shenggao Building ,No.137,Xianxia Road, Shanghai City, China
Phone : 021-5887-9067 Facsimile : 021-5887-9069

For our local sales distributors and representatives, please refer to "sales network" of our website.

●Distributor:

■ All products contained in this catalogue are equipment and devices that are premised on use under the supervision of qualified personnel, and are not designed or produced for home-use or use by general consumers. ■ Specifications, design and so forth are subject to change without prior notice to improve the quality. ■ Product names and prices are subject to change and production may be discontinued when necessary. ■ Product names, company names and brand names contained in this catalogue represent the respective registered trade name or trade mark. ■ Colors, textures and so forth of photographs shown in this catalogue may differ from actual products due to a limited fidelity in printing. ■ Although every effort has been made to provide the information as accurate as possible for this catalogue, certain details have unavoidably been omitted due to limitations in space. ■ If you find any misprints or errors in this catalogue, it would be appreciated if you would inform us. ■ Please contact our distributors to confirm specifications, price, accessories or anything that may be unclear when placing an order or concluding a purchasing agreement.